

**NOTOR**

*Installation solutions for various suspended ceilings*

**FAGERHULT**

# Notor – for all types of suspended ceilings

Notor is a series of luminaires for recess installation in various types of suspended ceilings. Notor is available for single or continuous installation and can be installed in various formations to highlight the room.

Recessed Notor makes it possible to create endless lines of light. A practical and aesthetic geometric solution is also possible using an L-shaped unit. Discreet or striking – it is simple to adapt the nature of the lighting with the architecture in mind. Regardless of the small installation measurements, Notor combines high energy efficiency with good general light levels. A wide selection of louvres makes it possible to adapt the light pattern to the function of the room. Notor can be equipped with four different types of louvre with varied function – from effective direct light to diffuse incidental light.

The installation solution is quick and cost-efficient. Fixed ceilings, with visible or concealed grid, the result is the same: an elegant installation that highlights the room. Through carefully considered lighting planning where the luminaires are positioned regularly, Notor gives energy efficient and comfortable general light corresponding to that of recessed luminaires of a significantly greater size.

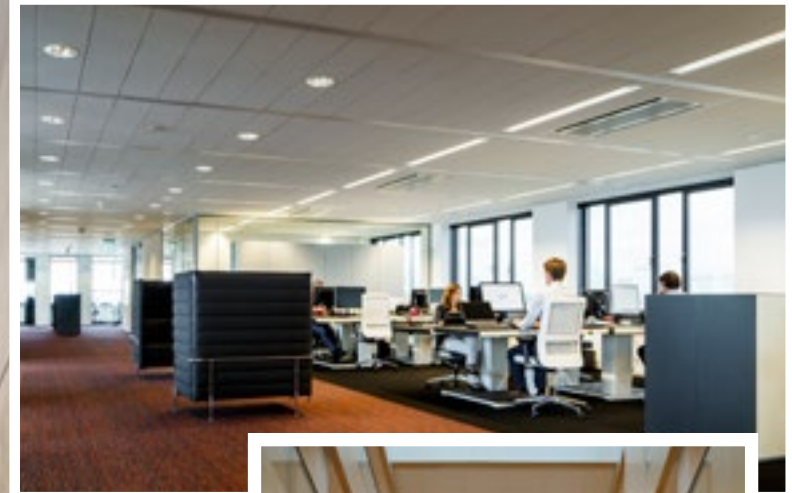

# Louvres



## Beta Opti

An active louvre where the LED module is integrated into one unit with double parabolic side and cross reflectors made of satin-matt, metallised aluminium with excellent reflection characteristics. Beta Opti gives complete control of the light as the reflectors precision-control the light down and out of the luminaire in a classic so-called batwing-shaped light distribution. All light is used without glare. The light from the LED module is diffused through a technical film, giving a glare-free and contrasting light that meets the requirements of EN 12464-1.



## Delta

A micro-prism louvre made of acrylic (PMMA) with good optical characteristics that screens the light at critical angles and reinforces the aesthetic experience.

Delta provides direction-free light, which makes Delta a suitable choice for working with computer monitors or in flexible office environments. Most models with Delta louvre meet the requirements of EN 12464-1.



## Opal

Opal louvres diffuse and spread the light out of the luminaire and are made of frosted acrylic (PMMA).

For recessed Notor, we offer two different versions that give different impressions:

Opal Dropped is an extruded profile that is dropped 10 mm below the luminaire and provides ambient luminance for the ceiling and wall.

Opal Flush consists of a frosted plate in the luminaire.

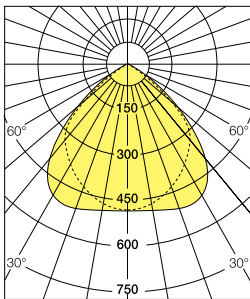

Beta Opti

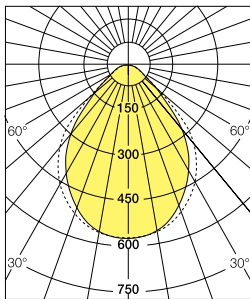

Delta

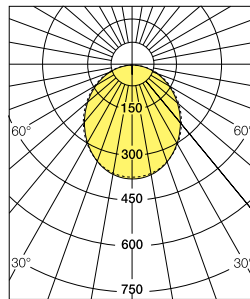

Opal Flush

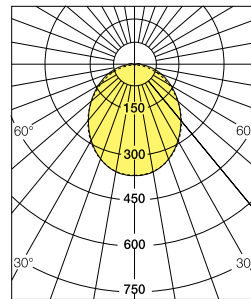

Opal Dropped



# Notor in ceilings with visible T-bars or fixed ceilings

In ceilings with visible T-bars, the ceiling panels are laid on grid.

Notor can be installed either on top of grid or suspended underneath; in the latter case, Notor is hung using suspension brackets fixed to the edge of the T-bar. Visible grids require T-bars c/c 100 mm on each side of Notor.

Please note that 600 mm luminaires cannot always be installed in ceilings with a visible grid (depending on the type of louvre).

In fixed ceilings, a 80 mm wide cut-out is made in the ceiling corresponding to the length of the luminaire or line of luminaires. Notor is hung using mounting brackets on the upper side of the ceiling.

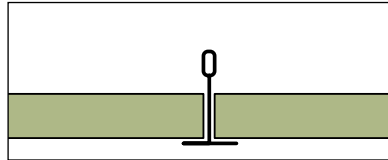

## A-edge

A solution with visible grid. The ceiling panels are laid in the grid.

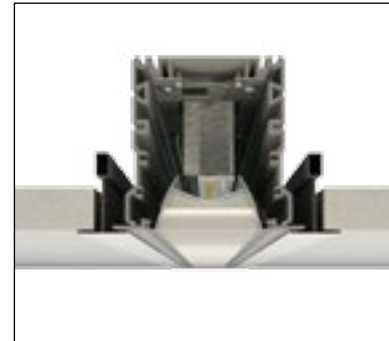

*Notor Beta Opti installed in A-edge laid in the ceiling.*

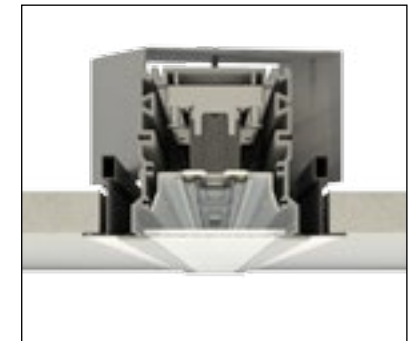

*Notor Delta in A-edge suspended in the ceiling.*

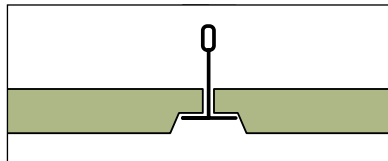

## E-edge

A ceiling with visible grid. The ceiling panels have a sunken edge, which means that the absorber's surface hangs down below the grid and partly conceals the grid.



*Notor Opal Dropped installed in E-edge laid in the ceiling.*



*Notor Opal Flush installed in E-edge suspended in the ceiling.*



*Notor Delta in fixed ceiling.*

# Installation in ceilings with visible grid or in fixed ceilings

## Installation in ceilings with visible grid

Prepare the grid with an extra T-bar along the entire length of the luminaire, c/c 100.

We recommend installing Notor from below. Mounting brackets are used to lock Notor to the T-bar.

If the luminaire is supposed to lie on the grid, remember that long lengths can be difficult to get up through the T-bar grid. It is not possible to feed Notor through the opening for the luminaire from underneath.

The dimensions 600, 1,200 and 2,400 are modular dimensions and not exact dimensions. For exact lengths, see the dimensional drawing.

[Installation video – single installation >](#)

[Installation video – continuous installation >](#)

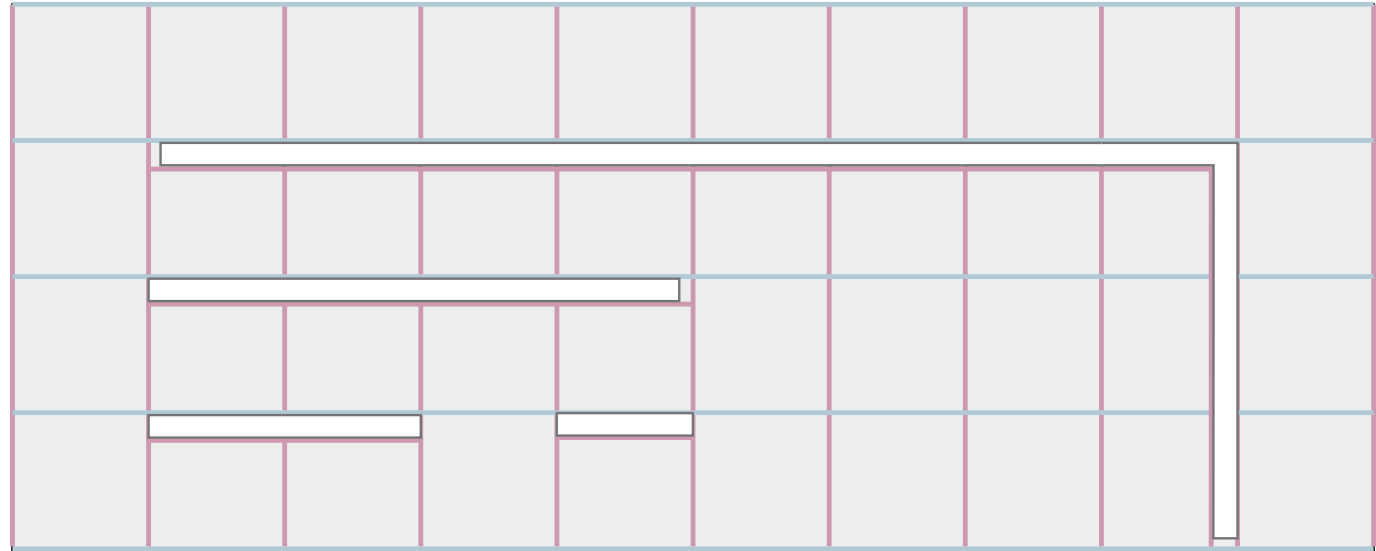

## Installation in fixed ceilings

In fixed ceilings, the ceiling is prepared with a cut-out that is 80 mm wide. Notor is installed from below. Mounting brackets are used to lock Notor to the ceiling.

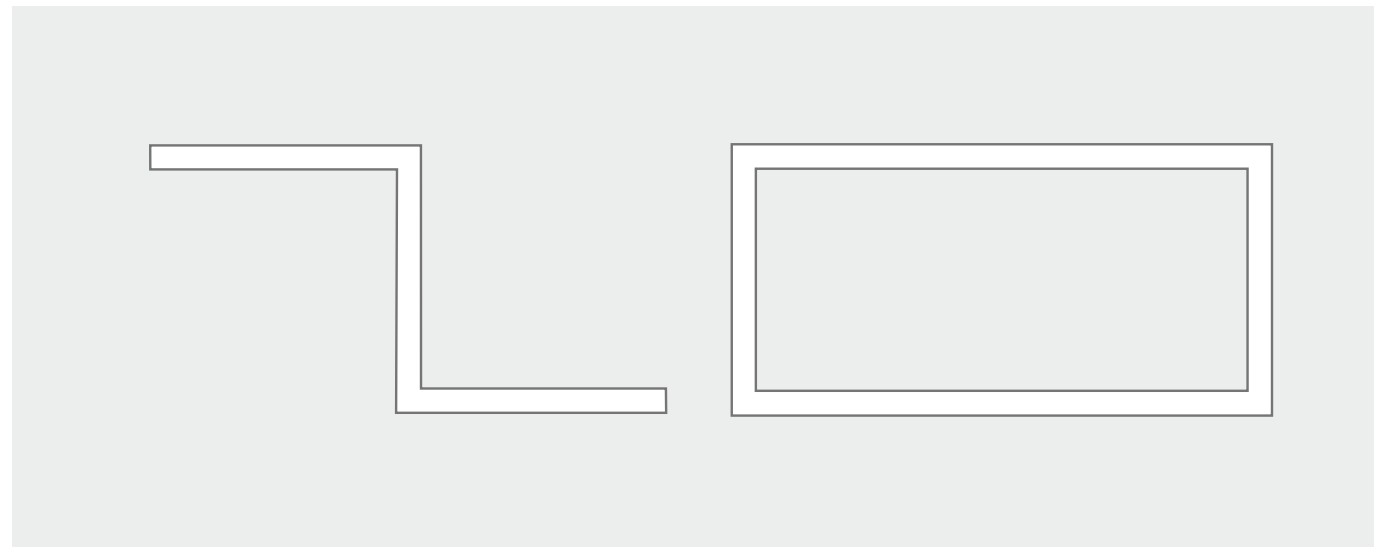
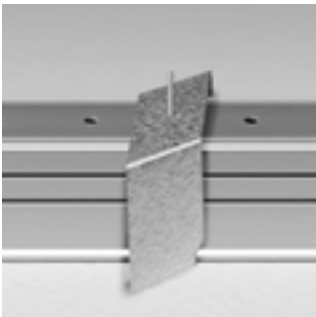

# Notor in ceilings with concealed grid

In ceilings with a concealed grid, connect Notor edge-to-edge with the suspended ceiling panels.

Notor is part of the grid and replaces a T-bar. Notor is suspended, as is the grid, in the structural deck and equipped with rails that are screwed to the body and connected to the suspended ceiling's cross T-bars.

Rails are fitted to Notor and the suspended ceiling's cross T-bars are attached to these. Please note that the rails' slots must align with the ceiling's cross T-bars.

In the event of single installation of the 1,200 length in the absorber's longitudinal direction, Notor will be positioned between two T-bars and, instead of being suspended, will be hung from the T-bars using suspension hooks.

Depending on how Notor is installed in the ceiling (the ceiling's design), it may be necessary to order cross T-bars and ceiling panels with customised dimensions from the suspended ceiling supplier.

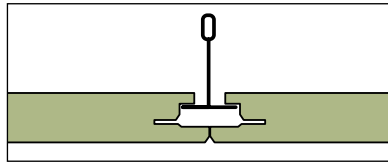

## X-edge (Rockfon)

A ceiling with a concealed grid (the structure is hidden by ceiling panels). The ceiling panels are bevelled on their lower edge.

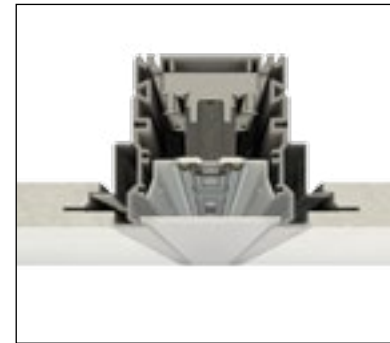

*Notor mounted in X-edge.*

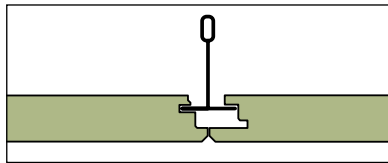

## DS-edge (Ecophon)

A ceiling with a concealed grid (the structure is hidden by ceiling panels). The ceiling panels are bevelled on their lower edge.

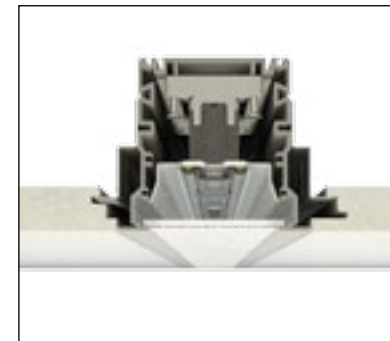

*Notor mounted in DS-edge.*

# Installation in ceilings with concealed grid

## A. Luminous line wall to wall

Entire ceiling panels can be laid between Notor.  
Notor ends with dummy sections against the wall.  
Notor is suspended from the structural deck.

[Installation video >](#)

## B. Luminous line parallel with T-bar

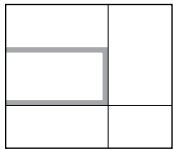

Notor installed displaced from the ceiling panels' joints. Special panels and cross T-bars are required on one side. The line ends with a dummy section. Notor is suspended from the structural deck.

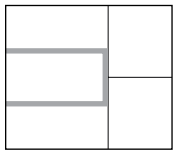

Notor installed in the centre of the ceiling panel's joint. Special panels and cross T-bars are required on both sides. The line ends with a dummy section. Notor is suspended from the structural deck.

[Installation video >](#)

## C. Single installation in the ceiling panel's longitudinal direction

Notor with modular dimension 1,200 is installed displaced from the ceiling panels' joints or installed in the centre of the ceiling panels' joints. Special panels and cross T-bars are required. Notor is laid on the grid with suspension hooks.

[Installation video >](#)

## D. Single installation in the centre of the ceiling panel

Notor is installed in the centre of the ceiling panel. A carrier rail between T-bars is required.

[Installation video >](#)

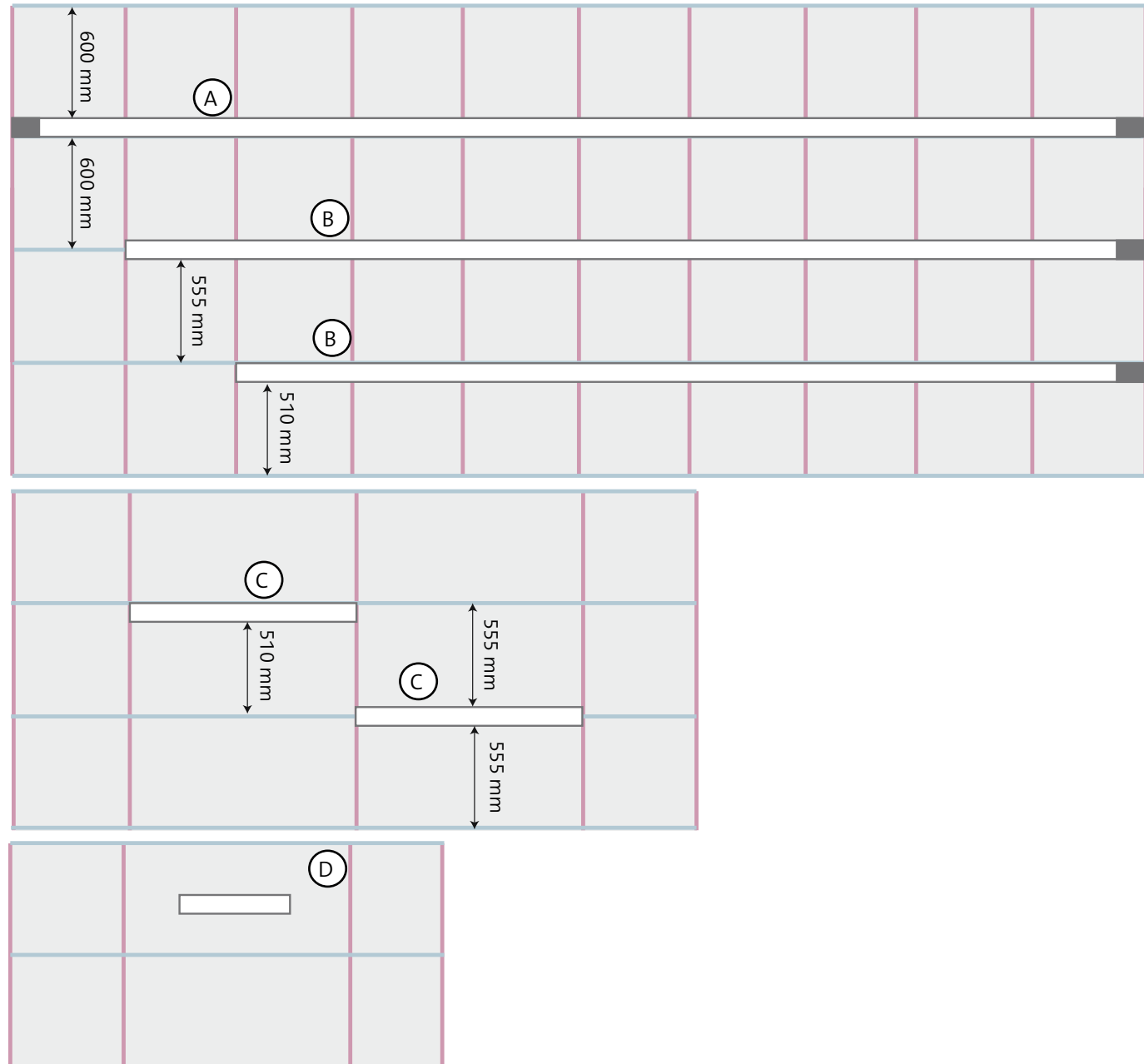

# Single installation

Luminaires for single installation are available in the modular dimensions 600, 1,200 and 2,400 mm. End-caps are ordered separately. Mounting brackets are ordered separately depending on the ceiling type.

For visible grids (A- or E-edge), an additional T-bar is required – two mounting brackets are needed per luminaire.

For concealed grids (X- and Ds-edge), single luminaires with the modular dimensions 600 and 1,200 are laid on the grid with custom end fittings.

*Please note that 600 mm luminaires cannot always be installed in ceilings with a visible grid (depending on the type of louvre).*

## Single installation in ceilings with visible grid

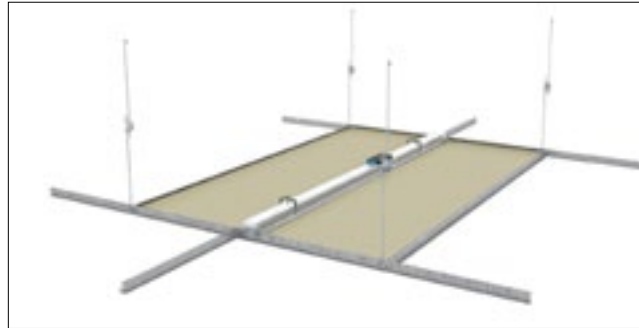

### Installation

Components	
Single luminaire	1 pc., desired modular dimensions
Mains cable	1 pc.
Mounting brackets	1 pair
End-caps for visible grid	1 pair (select model)
Extra T-bars	Provided by ceiling supplier

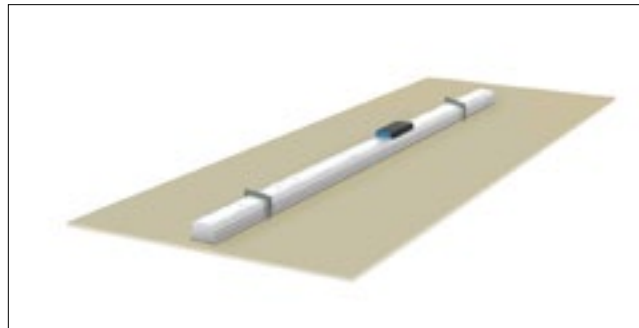

### Installation in solid ceiling

Components	
Single luminaire	1 pc., desired modular dimensions
Mains cable	1 pc.
End-caps for visible grid	1 pair (select model)
Mounting brackets	1 pair

## Single installation in ceilings with concealed grid

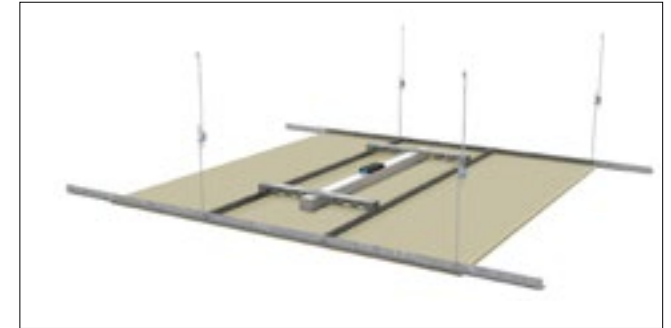

### Installation in the middle of the absorber (Solution D)

Components	
Single luminaire	1 pc., 600 mm
Mains cable	1 pc.
End-caps for concealed grid	1 pair (select model)
Notor carrier rail	1 pair

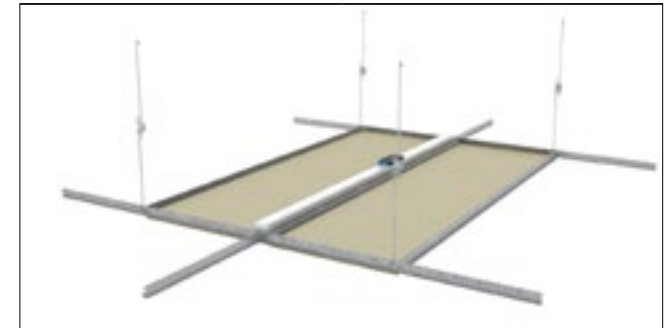

### Installation in the absorber's longitudinal direction (Solution C)

Components	
Single luminaire	1 pc., modular dimension 1,200
Mains cable	1 pc.
End-caps for concealed grid	1 pair (select model)
Suspension hooks	1 pair
Rails	1 pair, desired length



# Continuous installation

In the event of continuous installation, the luminaire line must always begin with a start luminaire with the modular dimensions 600, 1,200 and 2,400 mm. In the start luminaire for the Delta and Opal louvres, there are two cover plates located at the beginning and end of the luminaire line to absorb movements in the louvre and avoid gaps.

Luminaires for continuous installation are available in the modular dimensions 600, 1200 and 2400 mm. Supplement the start luminaire with the desired number of continuous installation luminaires to obtain the desired length of luminaire line in equal steps of 600 mm. If luminaires are wanted from wall to wall and the dimensions do not correspond with the luminaires' dimensions, dummy sections will be used against the walls.

With a visible grid (A- or E-edge) – one pair of mounting brackets per luminaire. Prepare the grid with an extra T-bar along the entire length, c/c 100. The mounting brackets folds over the T-bar and holds the luminaire up when the screw is tightened.

With a concealed grid (X- and Ds-edge), the luminaire is suspended from the structural deck. Rails are screwed to the luminaire and the luminaire becomes part of the grid.

## Mechanical connection between luminaires

Mechanical stability is achieved using a screw joint between the luminaires and guide pins in the luminaire profile ensure that it cannot distort.

## Electrical connection between luminaires

Connection cables and connection boxes are equipped with Wieland connectors for easy connection. In a continuous installation, the luminaires are connected with connection cables between the luminaires' connection boxes. These can also be used for single installation.

For consumption, see table under accessories.

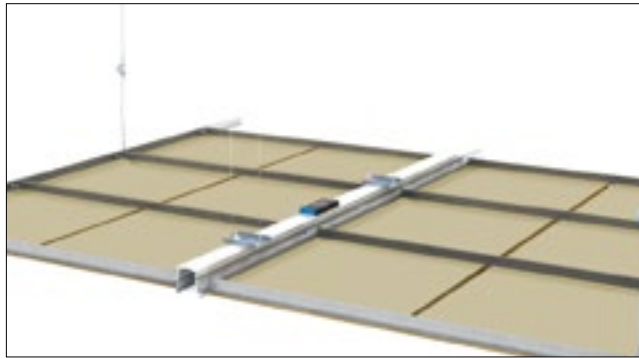

Series installation wall-to-wall (Solution A)

Components	
Start luminaire	1 pc., desired modular dimensions
Luminaire/s for continuous installation	x pcs., to the desired continuous installation length
Dummy section/s	1 pc. or 2 pcs. (depending on distance)
End-caps for concealed grid	1 pair (select model)
Mains cable	1 pc.
Connection cable/s	Desired number, between luminaires
Suspension bracket	1 pair/luminaire
Rails	Desired number, entire line length
Screw for rail	1 pack/500 (8 used per m)

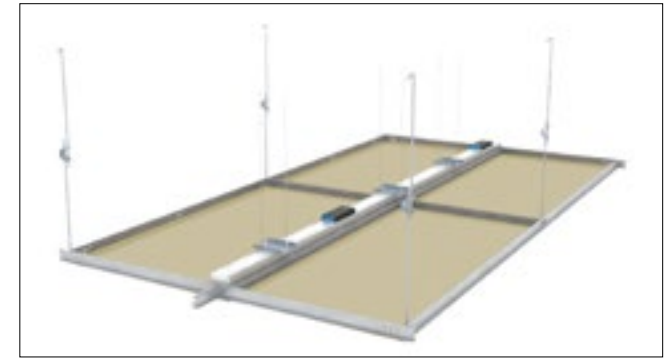

Series installation in the absorber's longitudinal direction (Solution B)

Components	
Start luminaire	1 pc., desired modular dimensions
Luminaire/s for continuous installation	x pcs., to the desired continuous installation length
Dummy section/s	1 pc. against the wall (depending on distance)
End-caps for concealed grid	1 pair (select model)
Suspension hooks	1 pair
Mains cable	1 pc.
Connection cable/s	Desired number, between luminaires
Suspension bracket	1 pair/luminaire
Rails	Desired number, entire line length
Screw for rail	1 pack/500 (8 used per m)

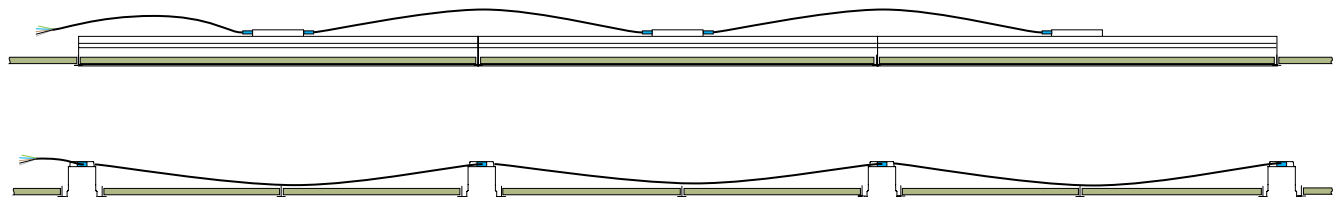

# Accessories

## Mains cables



**Mains cable, Wieland, 3-pin. 1-phase.**  
L = 2.0 m with female and earthed plug, 3 x 1.5 mm<sup>2</sup>.



**Mains cable, Wieland, 3-pin. 1-phase.**  
L = 2.0 m with female excl. plug, 3 x 1.5 mm<sup>2</sup>.



**Mains cable, Wieland, 5-pin. 1-phase + dimming.**  
L = 2.0 m with female, 5 x 1.5 mm<sup>2</sup>.

## Connection cables



**Connection cable Wieland, 3-pin. 1-phase.**  
White connection cable, Wieland, 3 x 1.5 mm<sup>2</sup>.  
L = 1.0 m, 2.0 m, 3.0 m.



**Connection cable, Wieland, 5-pin. 1-phase + dimming.**  
5 x 1.5 mm<sup>2</sup>.  
L = 1.0 m, 2.0 m, 2.5 m, 3.0 m.

### Connection cable lengths

Luminaire combination	Length, connection cable
600–600	1.0 m
600–1,200	1.0 m
600–2,400	2.0 m
1,200–1,200	2.0 m
1,200–2,400	2.0 m
2,400–2,400	2.5 m

## End-caps

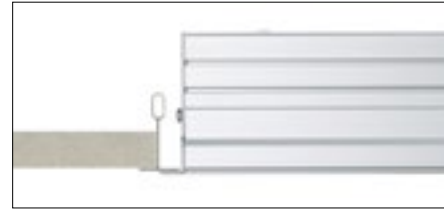

**End-caps for visible grid**  
For Beta Opti, Delta and Opal Flush.

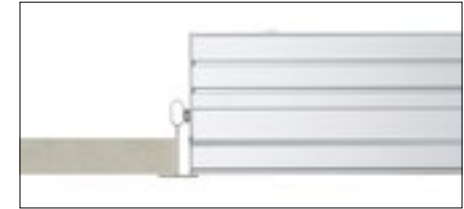

**End-cap for Notor in visible grid**  
For Beta Opti, Delta and Opal Flush.



**End-caps for visible grid**  
For Opal Dropped.

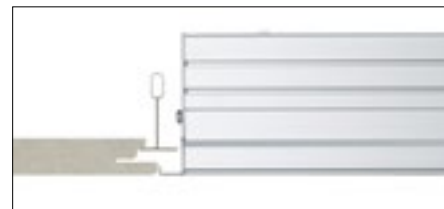

**End-caps for concealed grid**  
Angled for elegant connection to suspended ceiling panel.  
For Beta Opti, Delta and Opal Flush.

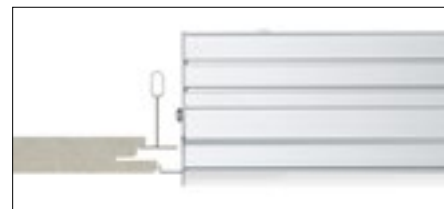

**End-caps for concealed grid**  
Angled for elegant connection to suspended ceiling panel.  
For Opal Dropped.

# Installation accessories

## Installation accessories concealed grid



### Suspension bracket/pair, Rockfon

With friction lock. To suspend Notor from the structural deck by installation in concealed grids.



*Suspension bracket Rockfon fitted to Notor.*



### Luminaire rail

Fitted to Notor for installation in concealed grids so that Notor becomes part of the structure. L=520 mm, 1,120 mm, 1,800 mm.



*Cross T-bars fitted to luminaire rail.*



### Suspension hook/pair

For single installation between two T-bars.



*Suspension hooks hang on the T-bar*

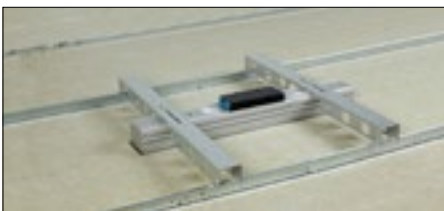

### Carrier rail/pair

For installation in the centre of a ceiling panel in concealed grids, L = 600 mm. Positioned between two T-bars.

## Installation accessories visible grid

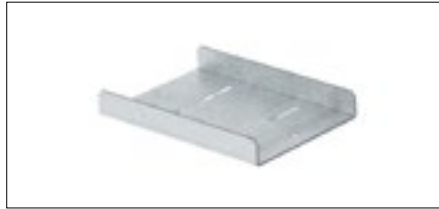

### Suspension bracket/pair, Ecophon

Without friction lock. To suspend Notor from the structural deck by installation in concealed grids.

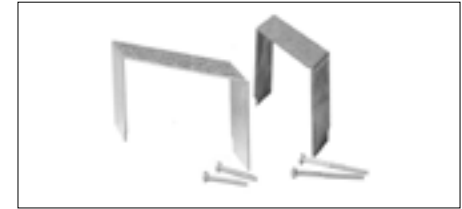

### Mounting brackets

Lock Notor to the T-bar in ceilings with visible grids or in fixed ceilings.



Fagerhult develops, manufactures and markets professional lighting systems for public environments. Our operations are run with a constant focus on design, function, flexibility and energy saving solutions.

Fagerhult is part of the Fagerhult Group, one of Europe's leading lighting groups with operations in more than 15 different countries. AB Fagerhult is listed on the NASDAQ OMX Nordic Exchange in Stockholm.

**FAGERHULT**

HEAD OFFICE  
SE-566 80 Habo, Sweden  
Tel. +46 (0)36 10 85 00  
[www.fagerhult.com](http://www.fagerhult.com)