

# FAGERHULT

SE - 566 80 Habo

## Evolume G2

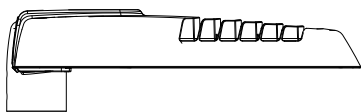

### Evolume 75

Max weight: 5 kg  
Max projected area:  
From below: 0,118 m<sup>2</sup>  
From the side: 0,029 m<sup>2</sup>

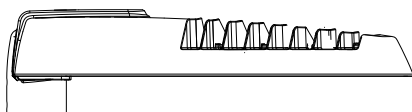

### Evolume 1

Max weight: 7 kg  
Max projected area:  
From below: 0,160 m<sup>2</sup>  
From the side: 0,038 m<sup>2</sup>

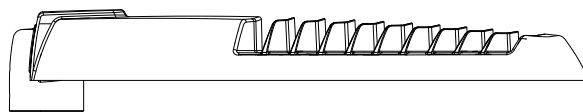

### Evolume 2

Max weight: 12 kg  
Max projected area:  
From below: 0,255 m<sup>2</sup>  
From the side: 0,053 m<sup>2</sup>

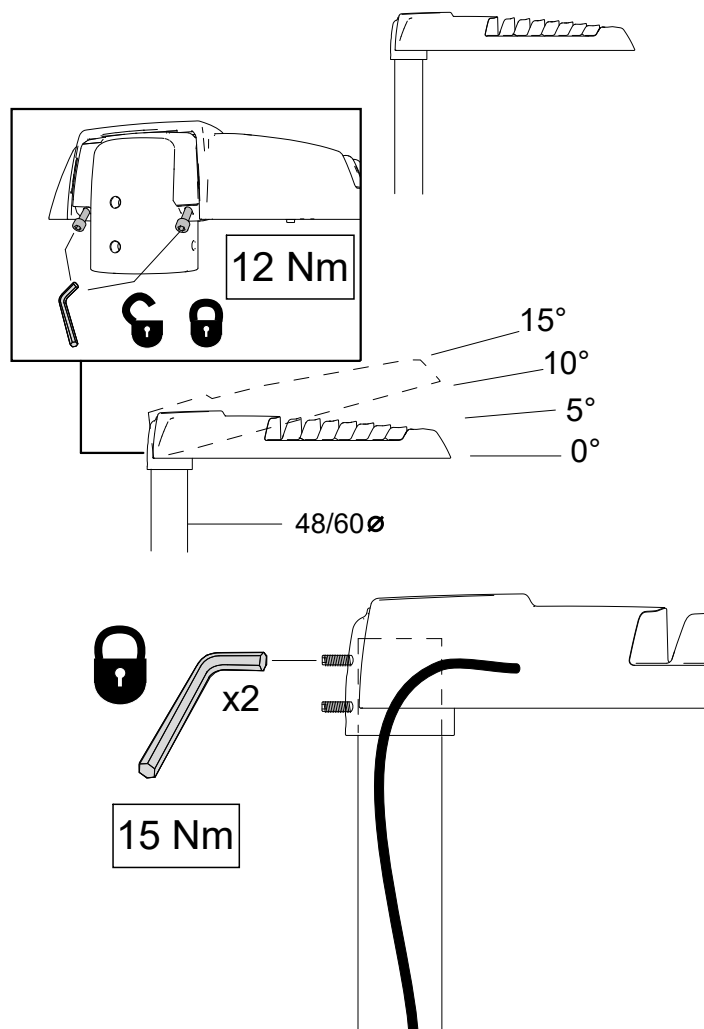
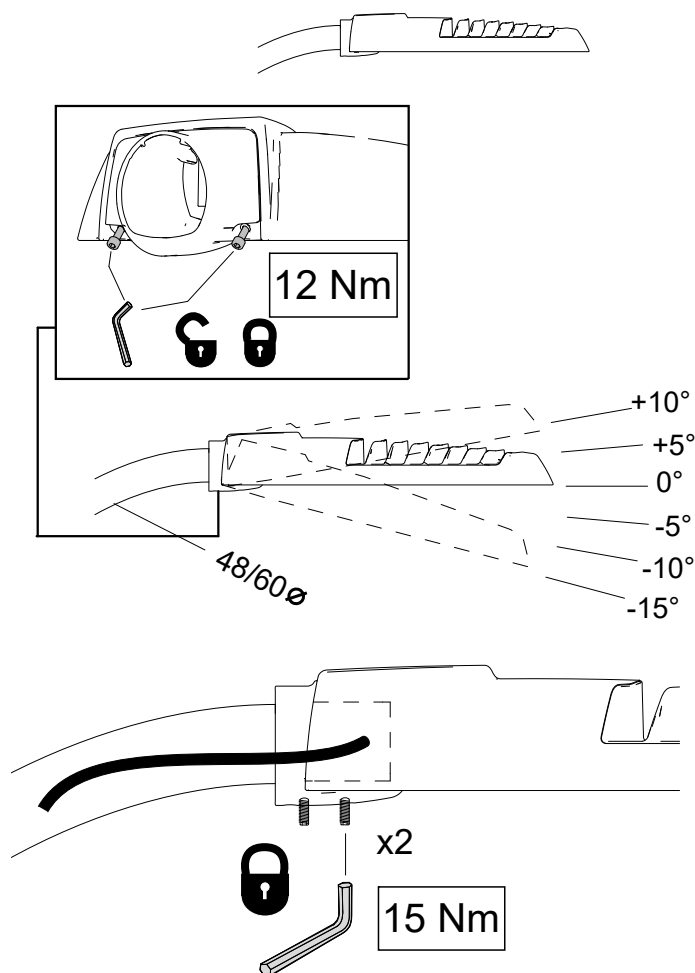

5446809 Utgåva/Edition 03

Manufactured by Fagerhult Sweden.  
For UK market importer Fagerhult UK  
33-34 Dolben Street, London, SE1 0UQ

**S** Ljuskälla och drivdon ska enbart bytas ut av tillverkaren eller dess utsedda person.

**GB** The light source and control gear shall only be replaced by the manufacturer or its designated person.

**S** Det är lämpligt att denna information överlämnas till användaren av anläggningen.

**GB** It is appropriate that this information is passed on to the users of the installation.

### Class II

**S** Om armaturens kabel skulle skadas skall den bytas av tillverkaren, eller av tillverkaren utsedd person.

**GB** If the cord of this luminaire is damaged, it shall exclusively be replaced by the manufacturer, or by the manufacturer designated person.

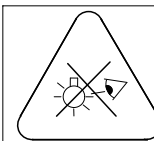

**S** Armaturen bör placeras så att långvarigt tittande direkt in i armaturen inte förväntas på ett avstånd närmre än 1 m.

**GB** The luminaire should be positioned so that prolonged staring into the luminaire at a distance closer than 1 m is not expected.

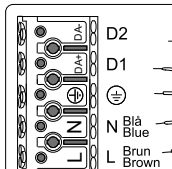

**S** Grundläggande isolering mellan nät och styr ledning.

**GB** Basic insulation between mains and control wiring.